

Big Segment LED Display

Dimension and Circuit

ASSEMBLY BOARD

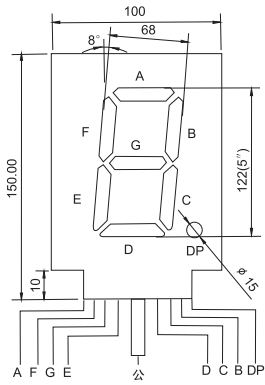

BL-SE500EA



BL-SE500DP



BL-SE500 Series

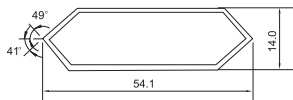

定位柱记号 竖条 ⊕
横条 ○

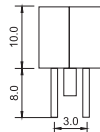
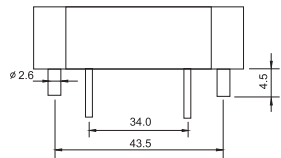

ASSEMBLY BOARD

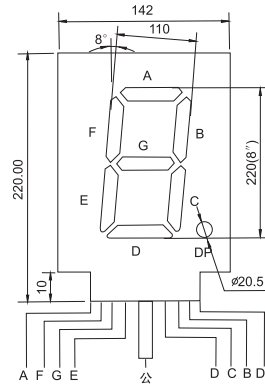

BL-SE800EA

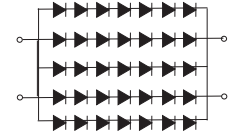

BL-SE800DP



BL-SE800 Series

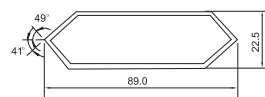

定位柱记号 竖条 ⊕
横条 ○

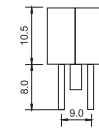
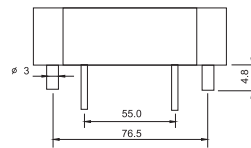

BL-SE700 SEGMENT Dimension

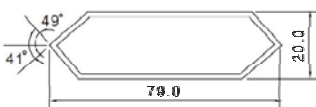

定位柱记号 竖条 ⊕
横条 ○

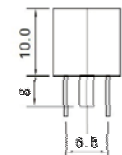
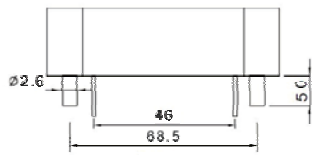

BL-SE700 Series

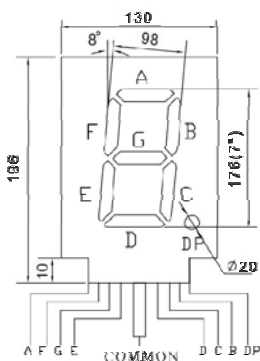

Segment Circuit

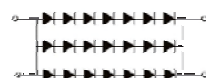

DP Circuit



ASSEMBLY BOARD

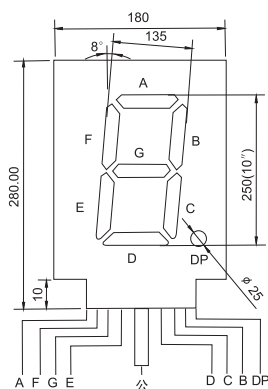

BL-SE1000EA

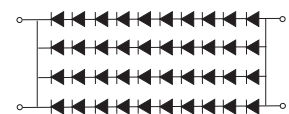

BL-SE1000DP



BL-SE1000 Series

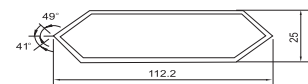

定位柱记号 竖条 ⊕
横条 ○

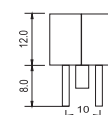
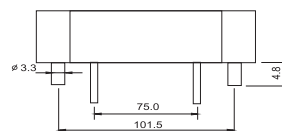

Big Segment LED Display

Dimension and Circuit

ASSEMBLY BOARD

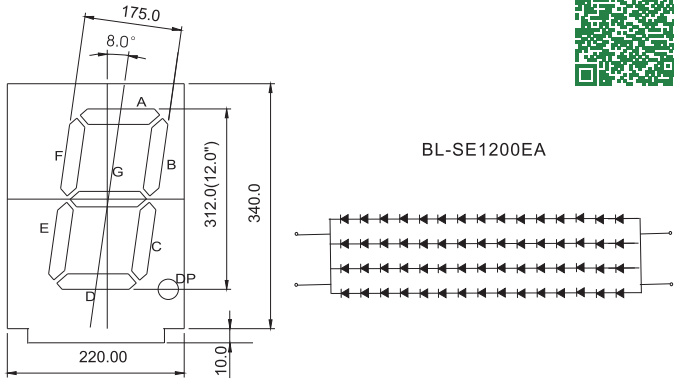

BL-SE1200EA

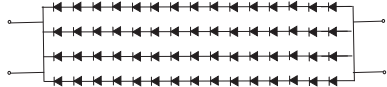

BL-SE1200 Series

Segment drawing

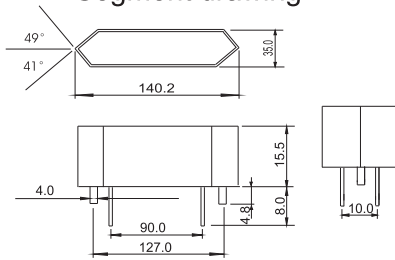

ASSEMBLY BOARD

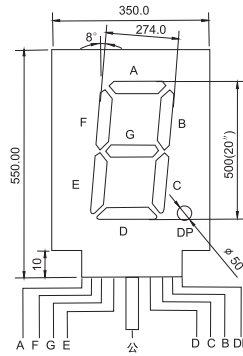

BL-SE2000EA

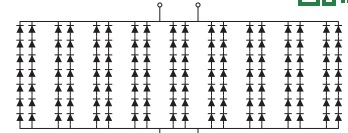

BL-SE2000DP



BL-SE2000 Series

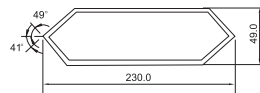

定位柱记号 竖条 ⊕
横条 ○

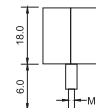
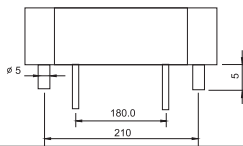

ASSEMBLY BOARD

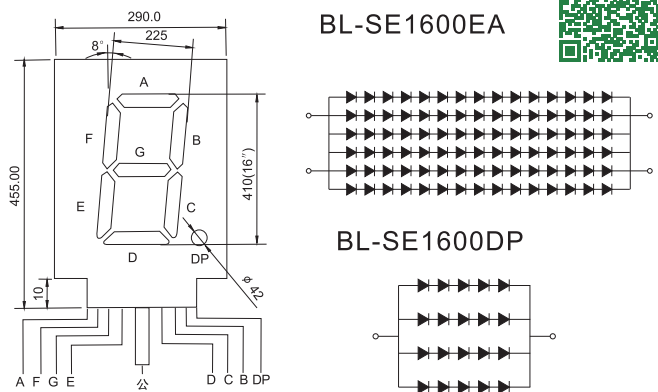

BL-SE1600EA

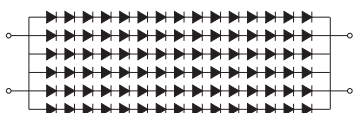

BL-SE1600DP

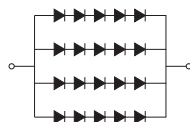

BL-SE1600 Series

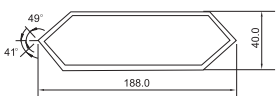

定位柱记号 竖条 ⊕
横条 ○

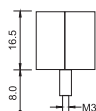
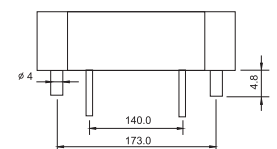

BL-S700X-11 Series

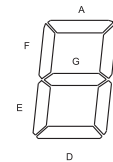
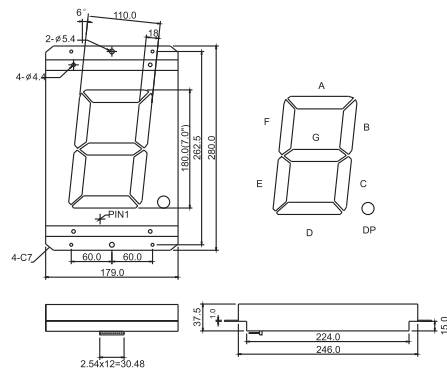

BL-S700A-11

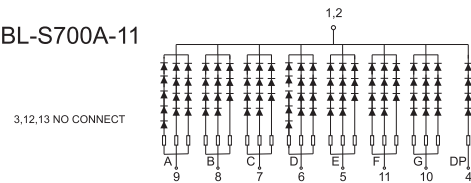

BL-S700B-11

