

## SUPER FLUX LED LAMP, 4PIN LED

BL-FL760Rxx

### Features:

- 7.62\*7.62\*3.5MM, flat round top, SUPER FLUX LED LAMP
- Ultra brightness.
- Wide Viewing Angles.
- Ideal For Backlight and Indicator
- RoHs Compliance



### □ Electrical-optical characteristics: (Ta=25°C) (Test Condition: IF=70mA)

Part Number	Chip			Lens Type	Forward Voltage(VF) Unit:V		Luminous Intensity (Iv) Unit:mcd		Viewing Angle 2θ1/2 (deg)
	Emitted Color	Material	λp (nm)		Typ	Max	Min.	Typ.	
					BL-FL760RURC	Ultra Red	AlGaAs,DDH	660	
BL-FL760RUEC	Ultra Red	AlGaInP	630	2.10	2.50	800	1500		
BL-FL760RUYC	Ultra Yellow	AlGaInP	590	2.10	2.50	600	1300		
BL-FL760RUGC	Ultra Green	AlGaInP	574	2.20	2.50	200	700		
BL-FL760RPGC	Ultra Pure Green	InGaN	525	3.10	4.50	1000	5000		
BL-FL760RBGC	Ultra Bluish Green	InGaN	505	3.10	4.50	800	4000		
BL-FL760RUBC	Ultra Blue	InGaN	470	3.10	4.20	800	2000		
BL-FL760RUWC	Ultra White	InGaN	/	3.10	4.20	1000	5000		

### □ Absolute maximum ratings (Ta=25°C)

Parameter	UR	UE	UY	UG	PG	BG	UB	W	Unit
Forward Current I <sub>F</sub>	25	30	30	30	30	30	30	30	mA
Power Dissipation P <sub>d</sub>	60	65	65	75	110	110	120	120	mW
Reverse Voltage V <sub>R</sub>	5	5	5	5	5	5	5	5	V
Peak Forward Current I <sub>PF</sub> (Duty 1/10 @1KHZ)	150	150	150	150	150	100	100	100	mA
Operation Temperature T <sub>OPR</sub>	-40 to +80								°C
Storage Temperature T <sub>STG</sub>	-40 to +85								°C
Lead Soldering Temperature T <sub>SOL</sub>	Max.260±5°C for 3 sec Max. (1.6mm from the base of the epoxy bulb)								°C

**SUPER FLUX LED LAMP, 4PIN LED**

**BL-FL760Rxx**

□ **Package configuration & Internal circuit diagram**

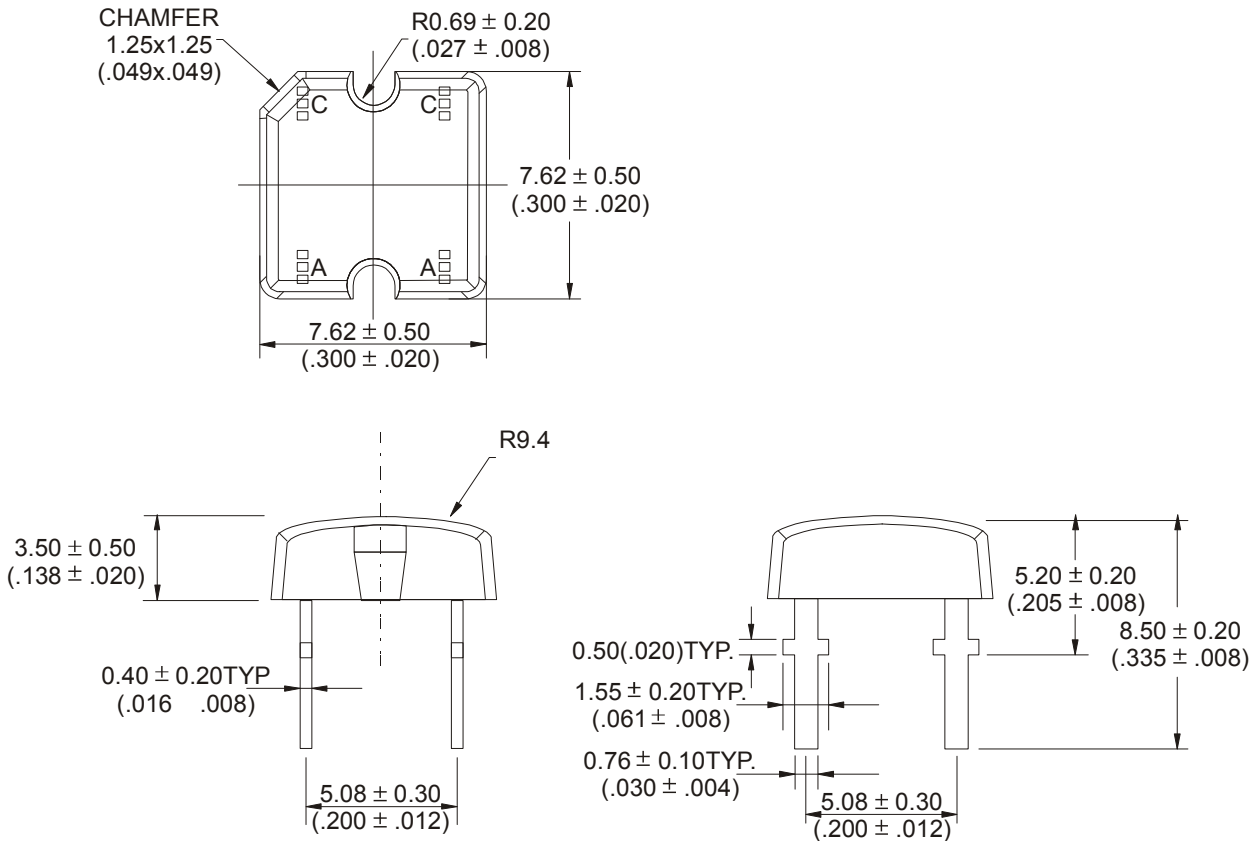

**Notes:**

1. All dimensions are in millimeters (inches)
2. Tolerance is ±0.25(0.01")unless otherwise noted.
3. Specifications are subject to change without notice.

# SUPER FLUX LED LAMP, 4PIN LED

**BL-FL760Rxx**

## □ Typical electrical-optical characteristics curves:

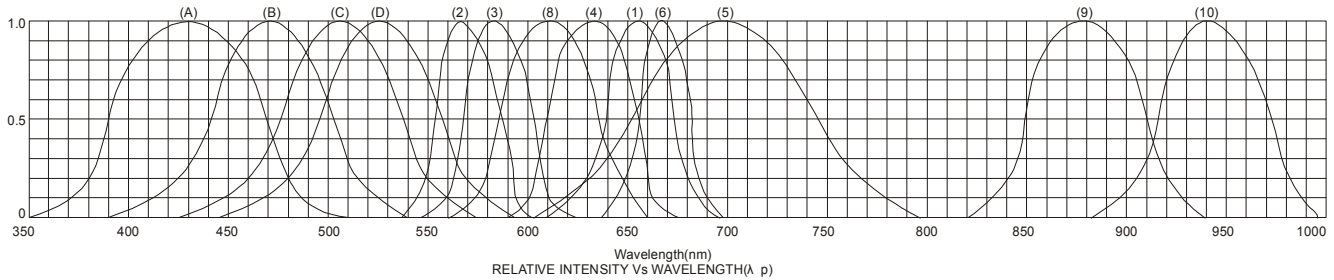

- (1) - GaAsP/GaAs 655nm/Red
- (2) - GaP 570nm/Yellow Green
- (3) - GaAsP/GaP 585nm/Yellow
- (4) - GaAsP/GaP 635nm/Orange & Hi-Eff Red
- (5) - GaP 700nm/Bright Red
- (6) - GaAlAs/GaAs 660nm/Super Red
- (8) - GaAsP/GaP 610nm/Super Red
- (9) - GaAlAs 880nm
- (10) - GaAs/GaAs & GaAlAs/GaAs 940nm
- (A) - GaN/SiC 430nm/Blue
- (B) - InGaN/SiC 470nm/Blue
- (C) - InGaN/SiC 505nm/Ultra Green
- (D) - InGaN/SiC 525nm/Ultra Green

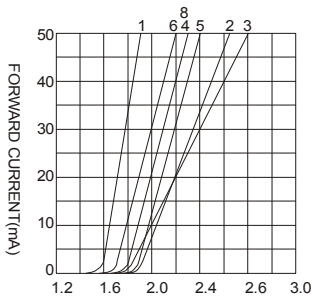

FORWARD VOLTAGE (Vf)  
FORWARD CURRENT VS.  
FORWARD VOLTAGE

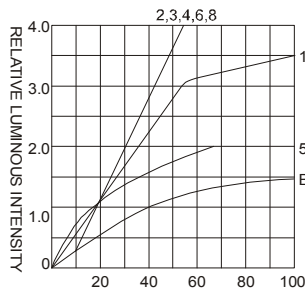

FORWARD CURRENT (mA)  
RELATIVE LUMINOUS  
INTENSITY VS. FORWARD  
CURRENT

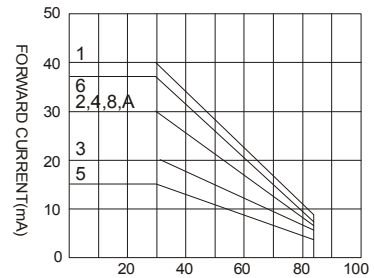

AMBIENT TEMPERATURE Ta(°C)  
FORWARD CURRENT VS. AMBIENT  
TEMPERATURE

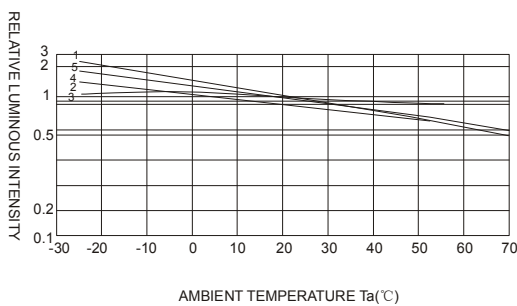

AMBIENT TEMPERATURE Ta(°C)

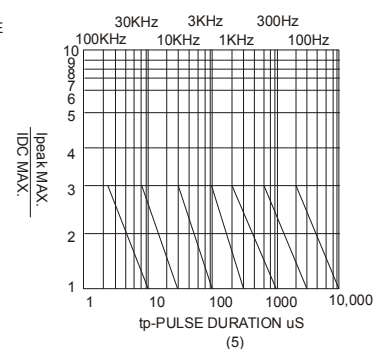
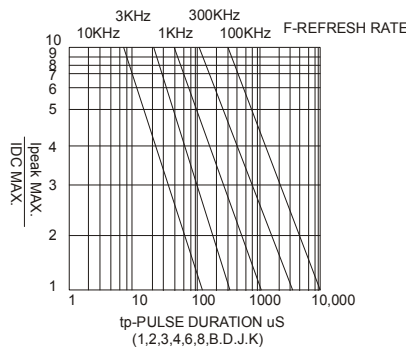

NOTE: 25°C free air temperature unless otherwise specified

**SUPER FLUX LED LAMP, 4PIN LED**

**BL-FL760Rxx**

**□ Packing and weighting**

